

# Mounting Adapters

Series 2100, 2600, 5300, 6100 Switch Accessories

Series 65, 67, 68, 72, 73, 75 and 98



## Series 65

- CS option snaps in from front of panel.
- HM option uses U-shaped bracket from back of panel.
- Mounts in panel thickness up to 1/8".
- For panels 1/8"-1/4" thick, specify 65ZCS.
- Uses L63 lens (0.74" square).
- Fingernail grooves in lens (L63W-FG) are recommended for easy lens removal.
- Series 65 is supplied with a 0.94" square flange.
- Mounts in a 0.875" (+0.010,-0.000) square hole.

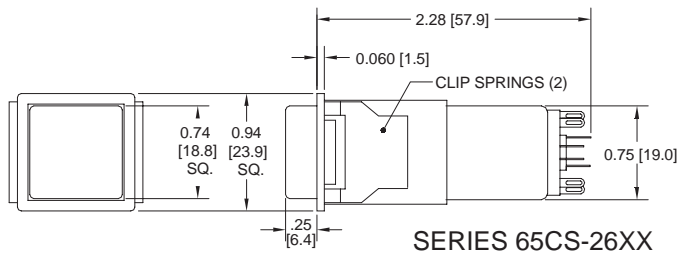

SERIES 65CS-26XX

## Series 67 and 68

- CS option snaps in from front of panel.
- HM option uses U-shaped bracket from back of panel.
- Mounts in panel thickness up to 1/8".
- For panels 1/8"-1/4" thick, specify 67ZCS or 68ZCS.
- Uses L63 lens (0.74" square).
- Fingernail grooves in lens (L63W-FG) are recommended for easy lens removal.
- Mounts in a 0.875" (+0.010,-0.000) square hole.
- One 67- bezel and several 68- bezels may be mounted in a single rectangular cut-out.

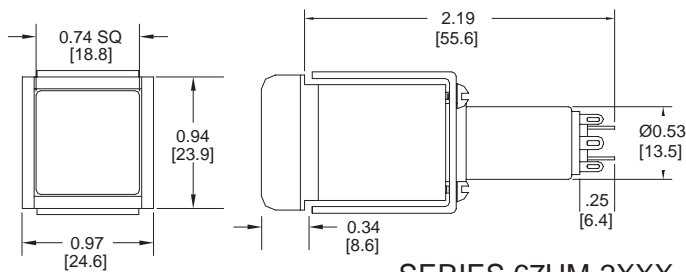

SERIES 67HM-2XXX

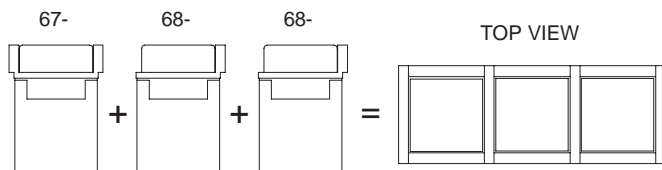

P/N 67LGCS-230,L63R-FG engr STOP (white fill)

## Series 72

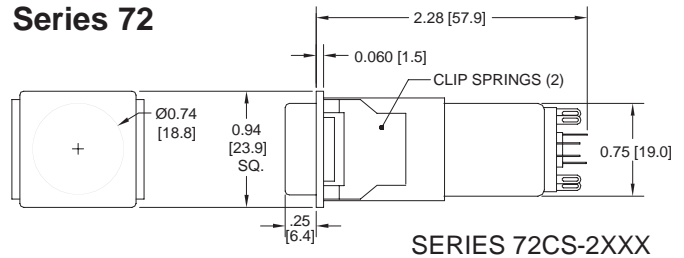

SERIES 72CS-2XXX

## Series 73

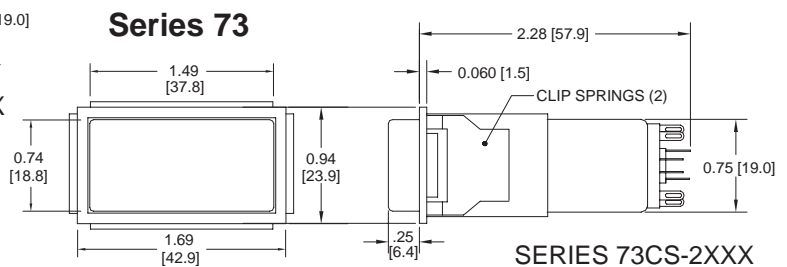

SERIES 73CS-2XXX

## Series 75

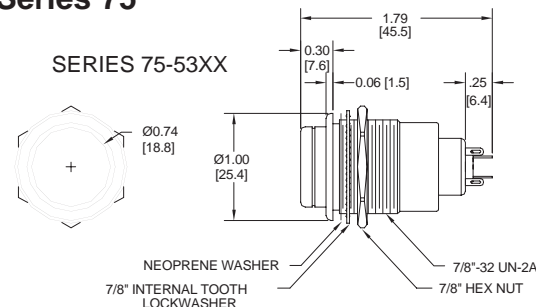

## Series 98

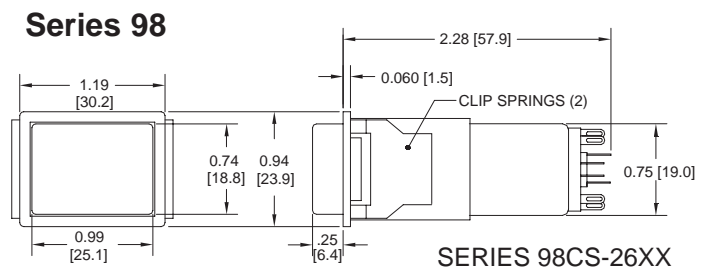

SERIES 98CS-26XX

electro-mech



www.electromechcomp.com

info@electromechcomp.com

1826 Floradale Ave. ♦ South El Monte, CA 91733-3689 USA ♦ (626) 442-7180 ♦ (888) 442-7180 ♦ Fax (626) 350-8070